

# LMR Master™

## Land Mobile Radio Modulation Analyzer and Signal Analyzer, Vector Network Analyzer, Spectrum Analyzer

### S412E

VNA: 500 kHz to 1.6 GHz

Spectrum Analyzer: 9 kHz to 1.6 GHz

#### Introduction

The S412E is Anritsu's second generation solution for installing and maintaining public safety systems. Built on Anritsu's ninth generation handheld platform, the S412E combines a high performance receiver/spectrum analyzer with the world's most advanced handheld vector network analyzer plus a powerful vector signal generator with internally adjustable power from 0 dBm to -130 dBm.

#### Spectrum Analyzer Highlights

- Measurements: Occupied Bandwidth, Channel Power, ACPR, C/I, Coverage Mapping
- Interference Analyzer: Spectrogram, Signal Strength, RSSI, Mapping
- 9 kHz to 1.6 GHz frequency coverage (Optional extension to 6 GHz)
- Dynamic Range: > 95 dB in 10 Hz RBW
- DANL: -152 dBm in 10 Hz RBW
- Phase Noise: -100 dBc/Hz max @ 10 kHz offset at 1 GHz
- Frequency Accuracy: 120 ppb standard (25 °C ± 25 °C); < 50 ppb after 3 minutes with GPS lock

#### VNA Analyzer Highlights

- 1-path, 2-port Vector Network Analyzer (VNA) w/ quad trace display
- 500 kHz to 1.6 GHz frequency coverage (Optional extension to 6 GHz)
- Intuitive Graphical User Interface (GUI) with convenient Touch Screen
- VNA-quality error correction for directivity and source match
- Outstanding calibration stability, up to 16 hours
- Arbitrary data points up to 4001
- IF Bandwidth selections of 10 Hz to 100 kHz
- 100 dB transmission dynamic range
- 850 μs/data point sweep speed

#### Land Mobile Radio Signal Analyzer Highlights

- Analyzes Narrowband FM analog systems
- Analyzes P25 (TIA-102.CAAA-C), P25 Phase 2 (TIA-102.CCAA), DMR (MotoTRBO™), NXDN™, and ITC-R PTC digital systems
- 100 kHz to 1.6 GHz frequency coverage (Optional extension to 6 GHz)
- Internal signal generator: 0.1 dB resolution, 0 dBm to -130 dBm (spec to -120 dBm)
- 2.0 dB signal generator accuracy (Typical)
- P25/P25p2, NXDN, and ETSI DMR BER test patterns including 1011 Hz, 1031 Hz, and 0.153
- Duplex test: Simultaneous analysis and generation of analog or digital LMR signals
- Independent control of both receive/transmit frequencies and test patterns

#### Capabilities and Functional Highlights

- 3 hour battery operation time
- Analog FM and digital LMR analyzer
- High accuracy internal power meter
- On-screen LMR Coverage Mapping (Outdoor and Indoor)
- Complies with MIL-PRF-28800F Class 2
- Certified for use in Explosive Atmosphere per MIL-PRF-28800F and MIL-STD-810G
- GPS tagging of saved traces
- USB data transfer
- < 5 minute warm-up time
- 8.4 inch daylight-viewable TFT LCD color resistive touchscreen – allows use while wearing gloves

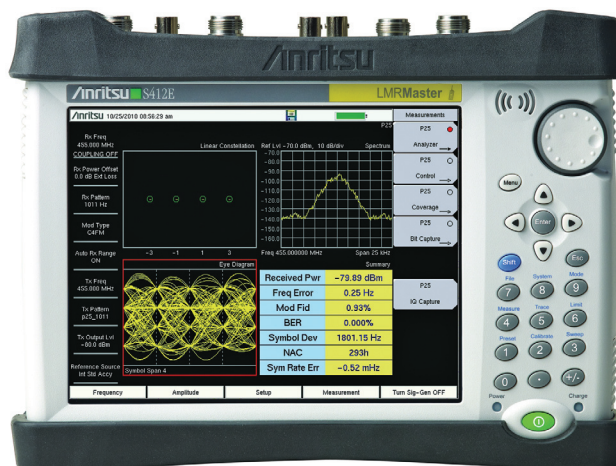

LMR Master™ S412E featuring 8.4 inch Daylight Viewable Touchscreen  
 Compact Size: 273 mm x 199 mm x 91 mm, (10.7 inch x 7.8 inch x 3.6 inch), Lightweight: 3.6 kg, (7.9 lbs)



## Spectrum Analyzer

### Measurements

Smart Measurements	Field Strength (uses antenna calibration tables to measure dBm/m <sup>2</sup> or dBmV/m) Occupied Bandwidth (measures 99% to 1% power channel of a signal) Channel Power (measures the total power in a specified bandwidth) ACPR (Adjacent Channel Power Ratio) AM/FM/SSB Audio Demodulation (Wide/Narrow FM, AM, Upper/Lower SSB) C/I (carrier-to-interference ratio) Emission Mask Coverage Mapping (requires option 0431)
--------------------	--

### Setup Parameters

Frequency	Center/Start/Stop, Span, Frequency Step, Signal Standard, Channel #, Channel Increment
Amplitude	Reference Level (RL), Scale, Attenuation Auto/Level, RL Offset, Pre-Amp On/Off, Detection
Span	Span, Span Up/Down (1-2-5), Full Span, Zero Span, Last Span
Bandwidth	RBW, Auto RBW, VBW, Auto VBW, RBW/VBW, Span/RBW
File	Save, Recall, Delete, Directory Management
Save/Recall	Setups, Measurements, Limit Lines, Screen Shots Jpeg (save only), Save-on-Event
Save-on-Event	Crossing Limit Line, Sweep Complete, Save-then-Stop, Clear All
Delete	Selected File, All Measurements, All Mode Files, All Content
Directory Management	Sort Method (Name/Type/Date), Ascend/Descend, Internal/USB, Copy, Format USB
Application Options	Bias-Tee (On/Off), Impedance (50 Ω, 75 Ω, Other)

### Sweep Functions

Sweep	Single/Continuous, Manual Trigger, Reset, Detection, Minimum Sweep Time, Trigger Type
Detection	Peak, RMS, Negative, Sample, Quasi-peak
Triggers	Free Run, External, Video, Change Position, Manual

### Trace Functions

Traces	Up to three Traces (A, B, C), View/Blank, Write/Hold, Trace A/B/C Operations
Trace A Operations	Normal, Max Hold, Min Hold, Average, # of Averages, (always the live trace)
Trace B Operations	A → B, B ↔ C, Max Hold, Min Hold
Trace C Operations	A → C, B ↔ C, Max Hold, Min Hold, A - B → C, B - A → C, Relative Reference (dB), Scale

### Marker Functions

Markers	Markers 1-6 each with a Delta Marker, or Marker 1 Reference with Six Delta Markers, Marker Table (On/Off), All Markers Off
Marker Types	Style (Fixed/Tracking), Noise Marker, Frequency Counter Marker, Marker Auto-Position Peak Search, Next Peak (Right/Left), Peak Threshold %, Set Marker to Channel, Marker Frequency to Center, Delta Marker to Span, Marker to Reference Level
Marker Table	1-6 markers frequency and amplitude plus delta markers frequency offset and amplitude

### Limit Line Functions

Limit Lines	Upper/Lower, On/Off, Edit, Move, Envelope, Advanced, Limit Alarm, Default Limit
Limit Line Edit	Frequency, Amplitude, Add Point, Add Vertical, Delete Point, Next Point Left/Right
Limit Line Move	To Current Center Frequency, By dB or Hz, To Marker 1, Offset from Marker 1
Limit Line Envelope	Create Envelope, Update Amplitude, Points (41 max), Offset, Shape Square/Slope
Limit Line Advanced	Type (Absolute/Relative), Mirror, Save/Recall

### Frequency

Frequency Range	9 kHz to 1.6 GHz, (6 GHz with Option 6)
Tuning Resolution	1 Hz
Frequency Reference Aging	1.0 ppm/year
Frequency Reference Accuracy	120 ppb (25 °C ± 25 °C) + aging, < 50 ppb + aging with GPS lock
Frequency Span	100 Hz to 1.6 GHz including zero span (100 Hz to 6 GHz with Option 6)
Sweep Time	100 ms, 10 μs to 600 seconds in zero span
Sweep Time Accuracy	± 2% in zero span

### Bandwidth

Resolution Bandwidth (RBW)	10 Hz to 3 MHz in 1-3 sequence ± 10% (1 MHz max in zero-span) (-3 dB bandwidth)
Video Bandwidth (VBW)	1 Hz to 3 MHz in 1-3 sequence (-3 dB bandwidth) (auto or manually selectable)
RBW with Quasi-Peak Detection	200 Hz, 9 KHz, 120 kHz (-6 dB bandwidth)
VBW with Quasi-Peak Detection	Auto VBW is On, RBW/VBW = 1



**Spectrum Analyzer** (Continued)

**Spectral Purity**

SSB Phase Noise @ 1 GHz -100 dBc/Hz, -110 dBc/Hz typical @ 10 kHz offset  
 -105 dBc/Hz, -112 dBc/Hz typical @ 100 kHz offset  
 -115 dBc/Hz, -121 dBc/Hz typical @ 1 MHz offset

**Amplitude Ranges**

Dynamic Range > 95 dB (2.4 GHz), 2/3 (TOI-DANL) in 10 Hz RBW  
 Measurement Range DANL to +26 dBm  
 Maximum Continuous Input +33 dBm  
 Display Range 1 to 15 dB/div in 1 dB steps, ten divisions displayed  
 Reference Level Range -120 dBm to +30 dBm  
 Attenuator Resolution 0 to 55 dB, 5.0 dB steps  
 Amplitude Units Log Scale Modes: dBm, dBV, dBmV, dBμV  
 Linear Scale Modes: nV, μV, mV, V, kV, nW, μW, mW, W, kW

**Amplitude Accuracy** (single sine wave input < Ref level, and > DANL, auto attenuation)

-10 °C to 50 °C After 30 Minute Warm-up Typical: ± 0.5 dB, 9 kHz to 6 GHz  
 Maximum: ± 1.3 dB, 9 kHz to 6 GHz

**Displayed Average Noise Level (DANL)**

	Preamp Off (Reference Level -20 dBm)		Preamp On (Reference Level -50 dBm)	
	Maximum	Typical	Maximum	Typical
(RBW = 1 Hz, 0 dB attenuation)				
10 MHz to 2.4 GHz	-141 dBm	-146 dBm	-157 dBm	-162 dBm
> 2.4 GHz to 4 GHz	-137 dBm	-141 dBm	-154 dBm	-159 dBm
> 4 GHz to 5 GHz	-134 dBm	-138 dBm	-150 dBm	-155 dBm
> 5 GHz to 6 GHz	-126 dBm	-131 dBm	-143 dBm	-150 dBm
(RBW = 10 Hz, 0 dB attenuation)				
10 MHz to 2.4 GHz	-131 dBm	-136 dBm	-147 dBm	-152 dBm
> 2.4 GHz to 4 GHz	-127 dBm	-131 dBm	-144 dBm	-149 dBm
> 4 GHz to 5 GHz	-124 dBm	-128 dBm	-140 dBm	-145 dBm
> 5 GHz to 6 GHz	-116 dBm	-121 dBm	-133 dBm	-140 dBm

**Spurs**

Residual Spurious < -90 dBm (RF input terminated, 0 dB input attenuation, > 10 MHz)  
 Input-Related Spurious < -75 dBc (0 dB attenuation, -30 dBm input, span < 1.7 GHz, carrier offset > 4.5 MHz)  
 Exceptions, typical  
 < -70 dBc @ < 2.5 GHz, with 2072.5 MHz Input  
 < -68 dBc @ F1 - 280 MHz with F1 Input  
 < -70 dBc @ F1 + 190.5 MHz with F1 Input  
 < -52 dBc @ 7349 - 2F2 MHz, with F2 Input, where F2 < 2424.5 MHz  
 < -55 dBc @ 190.5 ± F1/2 MHz, F1 < 1 GHz

**Third-Order Intercept (TOI)** (Preamp Off (-20 dBm tones, 100 kHz apart, 10 dB attenuation))

800 MHz +16 dBm  
 2400 MHz +20 dBm  
 200 MHz to 2200 MHz +25 dBm, typical  
 > 2.2 GHz to 5.0 GHz +28 dBm, typical  
 > 5.0 GHz to 6.0 GHz +33 dBm, typical

**Second Harmonic Distortion** (Preamp Off, 0 dB input attenuation, -30 dBm input)

50 MHz -56 dBc  
 > 50 MHz to 200 MHz -60 dBc, typical  
 > 200 MHz to 3000 MHz -70 dBc, typical

**VSWR**

2:1, typical

 **Vector Network Analyzer**

**Definitions**

All specifications and characteristics apply under the following conditions, unless otherwise stated:

- After 15 minutes of warm-up time, where the instrument is left in the ON state.
- Temperature range is 25 °C ± 5 °C.
- All specifications apply when using internal reference.
- All specifications subject to change without notice. Please visit [www.anritsu.com](http://www.anritsu.com) for most current data sheet.
- Typical performance is the measured performance of an average unit.
- Recommended calibration cycle is 12 months.

**Frequency**

Frequency Range: 500 kHz to 1.6 GHz (500 kHz to 6.0 GHz with Option 16)

Frequency Accuracy: 2.5 ppm

Frequency Resolution: 1 Hz

**Typical Test Port Power**

LMR Master supports selection of either High (default) or Low test port power. Changing power after calibration can degrade the calibrated performance. Typical power by bands is shown in the following table.

Frequency Range	High Port Power	Low Port Power
500 kHz to ≤ 3 GHz	+3 dB	-25 dBm
3 GHz to ≤ 6 GHz	0 dB	-25 dBm

**Transmission Dynamic Range**

The transmission dynamic range (the difference between test port power and noise floor) using 10 Hz IF Bandwidth and High Port Power is shown in the following table.

Frequency Range	Dynamic Range
2 MHz to ≤ 4 GHz	100 dB
4 GHz to ≤ 6 GHz	90 dB

**Typical Sweep Speed**

The typical sweep speed for IF Bandwidth of 100 Hz, 1001 data points, and single display is shown in the following table. The two receiver architecture will simultaneously collect  $S_{21}$  and  $S_{11}$  (or  $S_{12}$  and  $S_{22}$ ) in a single sweep.

Frequency Range	Typical Sweep Speed
500 kHz to 6 GHz	850 μs / point

**Block Diagram**

As shown in the following block diagram, the LMR Master has a 2-port, 1-path architecture that automatically measures 2 S-parameters with error-correction precision inherent to VNA operation.

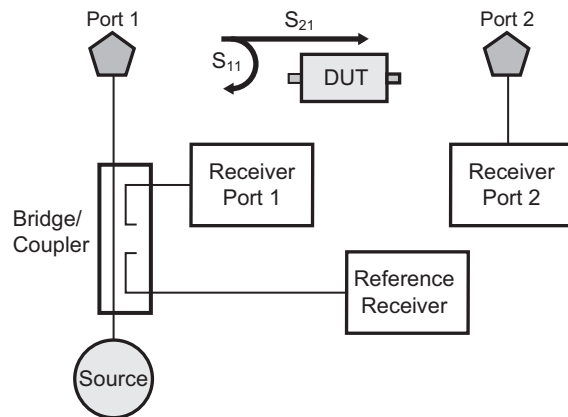

The above illustration is a simplified block diagram of LMR Master's 2-port, 1-path architecture. The magnitude and phase information gained from vector network data enables the LMR Master to make significant error corrections and provide improved field measurements.

 **Vector Network Analyzer** (Continued)

**High Port Power**

OSLxx50 Calibration Components (N-Connector) Corrected System Performance and Uncertainties:

S412E with 1-path, 2-port calibration including isolation using either OSLN50-1 or OSLNF50-1 Calibration Kits.

Frequency Range	Directivity
≤ 6 GHz	> 42 dB

Frequency Range	Typical High Port Power
≤ 3 GHz	+3 dBm
≤ 6 GHz	0 dBm



Precision calibration standards come in a convenient configuration for field work.

**Measurement Uncertainties**

The following graphs provide measurement uncertainty at 23 °C ± 5 °C for the above indicated connector type and calibration. Errors are worse-case contributions of residual directivity, source match, frequency response, network analyzer dynamic range, and connector repeatability. For two-port measurements, transmission tracking, crosstalk, and physical load match termination were added. Isolation calibration and an IF Bandwidth of 10 Hz is used.

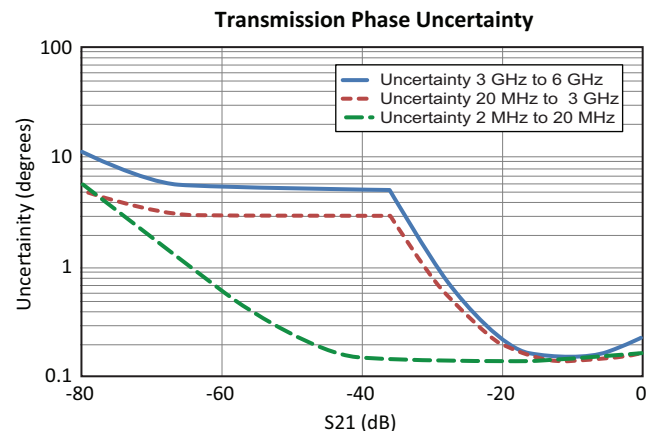
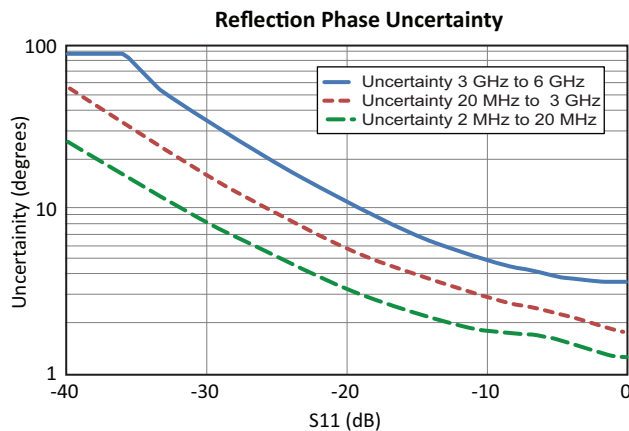
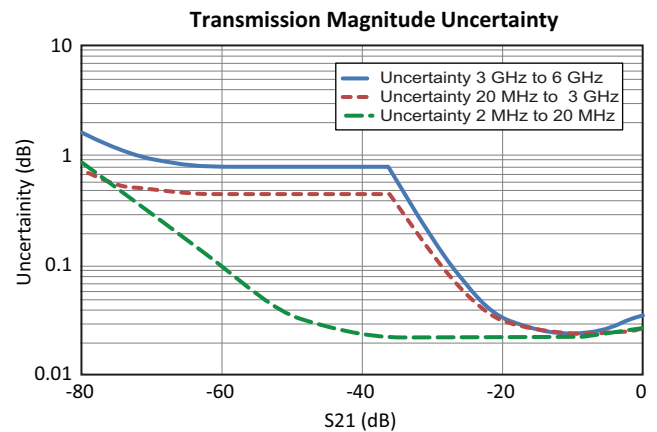
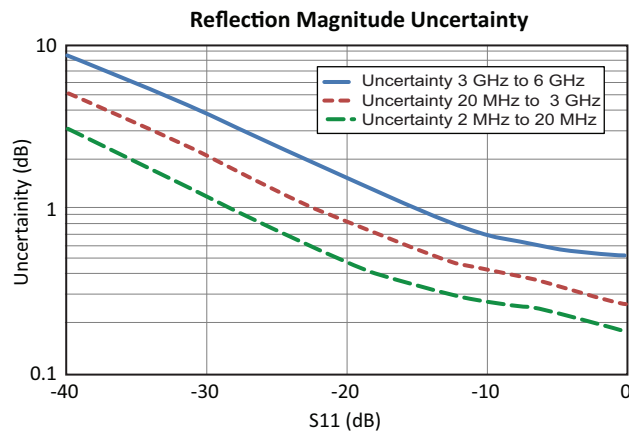

 **Vector Network Analyzer** (Continued)

**Low Port Power**

OSLxx50 Calibration Components (N-Connector) Corrected System Performance and Uncertainties:

S412E with 1-path, 2-port calibration including isolation using either OSLN50-1 or OSLNF50-1 Calibration Kits.

Frequency Range	Directivity
≤ 6 GHz	> 42 dB

Frequency Range	Typical Low Port Power
≤ 3 GHz	-25 dBm
≤ 6 GHz	-25 dBm



Precision calibration standards come in a convenient configuration for field work.

**Measurement Uncertainties**

The following graphs provide measurement uncertainty at 23 °C ± 5 °C for the above indicated connector type and calibration. Errors are worse-case contributions of residual directivity, source match, frequency response, network analyzer dynamic range, and connector repeatability. For two-port measurements, transmission tracking, crosstalk, and physical load match termination were added. Isolation calibration and an IF Bandwidth of 10 Hz is used.

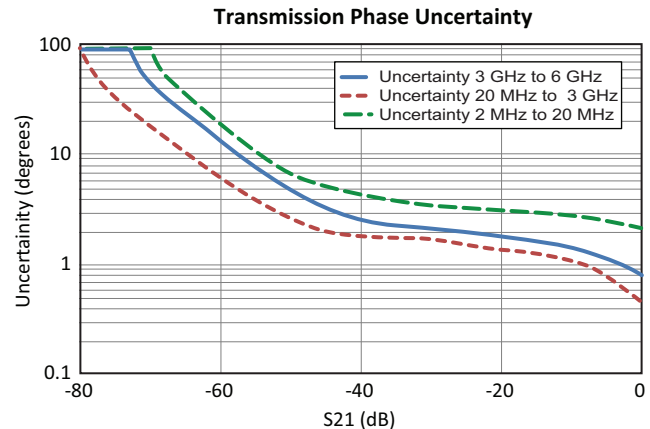
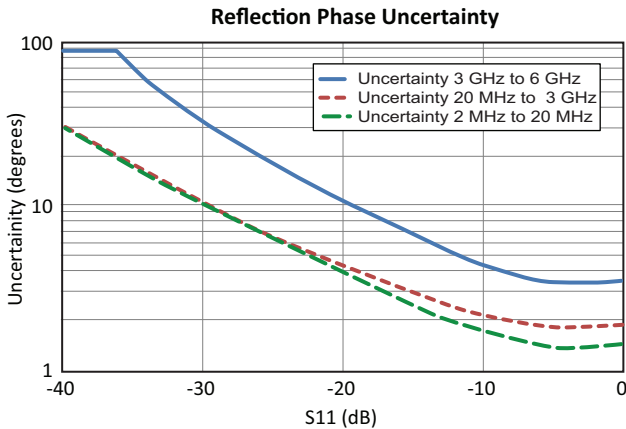
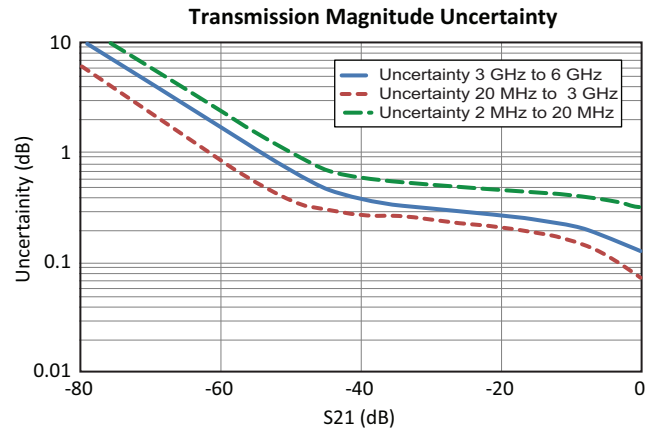
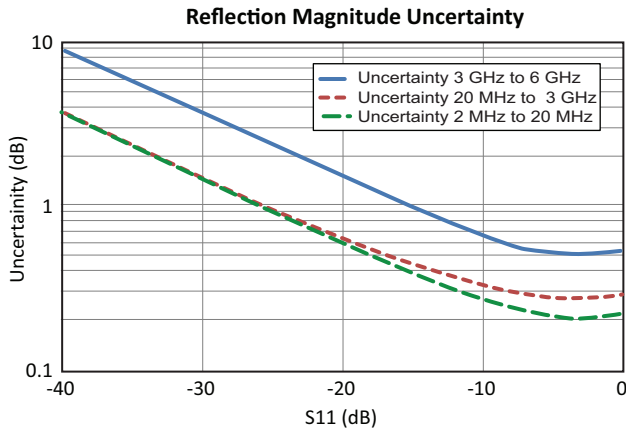

**Vector Network Analyzer** (Continued)

**Bias Tee (Option 0010)**

For tower mounted amplifier tests, the S412E with optional internal bias tees can supply both DC and RF signals on the center conductor of the cable during measurements. For frequency sweeps in excess of 2 MHz, the LMR Master can supply internal voltage control from +12 to +32 V in 0.1 V steps up to 450 mA. Bias is available on VNA Port 2 and the SPA Input (RF In) for use with antenna pre-amplifiers.

<b>Frequency Range</b>	2 MHz to 4/6 GHz at VNA Port 2
<b>Internal Voltage/Current</b>	+12 V to +32 V at 450 mA. Steady state
<b>Internal Resolution</b>	0.1 V
<b>Bias Tee Selections</b>	Internal, Off

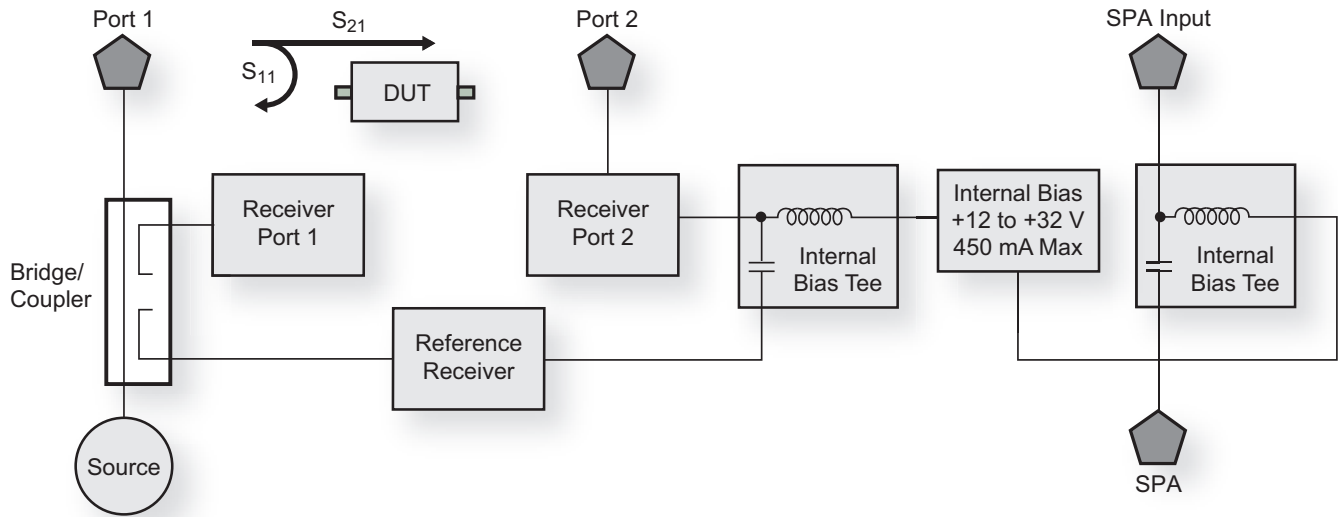

The Compact LMR Master offers optional integrated bias tee for supplying DC plus RF to the DUT as shown in this simplified block diagram.

**Vector Voltmeter (Option 0015)**

A phased array system relies on phase matched cables for nominal performance. For this class of application, the LMR Master offers this special software mode to simplify phase matching cables at a single frequency. The similarity between the popular vector voltmeter and this software mode ensures minimal training is required to phase match cables. Operation is as simple as configuring the display for absolute or relative measurements. The easy-to-read large fonts show either reflection or transmission measurements using impedance, magnitude, or VSWR readouts. For instrument landing system (ILS) or VHF Omni-directional Range (VOR) applications, a table view improves operator efficiency when phase matching up to twelve cables.

The S412E solution is superior because the signal source is included internally, precluding the need for an external signal generator.

<b>CW Frequency Range</b>	2 MHz to 6 GHz
<b>Measurement Display</b>	CW, Table (Twelve Entries, Plus Reference)
<b>Measurement Types</b>	Return Loss, Insertion
<b>Measurement Format</b>	dB/VSWR/Impedance

**Distance Domain (Option 0501)**

Distance-to-Fault Analysis is a powerful field test tool to analyze cables for faults, including minor discontinuities that may occur due to a loose connection, corrosion, or other aging effects. By using Frequency Domain Reflectometry (FDR), the VNA's DTF mode exploits a user-specified band of full power operational frequencies (instead of DC pulses from TDR approaches) to more precisely identify discontinuities. The VNA converts S-parameters from frequency domain into distance domain on the horizontal display axis, using a mathematical computation called Inverse Fourier Transform. Connect a reflection at the opposite end of the cable and the discontinuities appear versus distance to reveal any potential maintenance issues. When access to both ends of the cable is convenient, a similar distance domain analysis is available on transmission measurements.

Option 0501 Distance Domain will improve your productivity with displays of the cable in terms of discontinuities versus distance. This readout can then be compared against previous measurements (from stored data) to determine whether any degradations have occurred since installation (or the last maintenance activity). More importantly, you will know precisely where to go to fix the problem and minimize or prevent downtime of the system.

<b>Maximum Distance (4001 data points, 1.6 GHz span)</b>	374.9 m (1,229.9 feet)
<b>Maximum Distance (4001 data points, 6.0 GHz span)</b>	99.9 m (327.75 feet)
<b>Minimum Distance Resolution (1.6 GHz span)</b>	18.7 cm (7.36 inch)
<b>Minimum Distance Resolution (6.0 GHz span)</b>	4.99 cm (1.97 inch)
<b>Measurement Display</b>	Return Loss, VSWR
<b>Measurement Format</b>	dB, VSWR



**NBFM Analyzer and Coverage Mapping**

**Measurements**

NBFM Analyzer	NBFM Talk-Out Coverage (requires Option 0031 GPS and a suitable GPS antenna)
Carrier Power	RSSI
Carrier Frequency	SINAD
Frequency Error	THD
FM Deviation (Peak, Average, RMS)	
Modulation Rate	
SINAD	
Quieting	
THD	
Occupied Bandwidth (% Int Pwr or > dBc method)	
Decoded CTCSS/DCS/DTMF	
Encoded CTCSS/DCS/DTMF	

**Graphs**

NBFM Analyzer	NBFM Talk-Out Coverage
Spectrum	Outdoor measured values are overlaid on a geo-tagged map, or displayed on a value vs. time graph. Captured data is exportable to both KML and CSV text (Requires option 0031 GPS and a suitable GPS antenna). Indoor measured values are referenced by creating touchscreen points on a floorplan.
Audio Spectrum	
Audio Waveform/Scope	
Summary Display	

**Setup Parameters**

Frequency	Center Frequency
Amplitude	Reference level, Scale, Ext Attenuation, Auto Range, Adjust Range
Setup	Tone Type (CTCSS, DCS, DTMF)
Filters	High Pass (300 Hz, 3 kHz, None) and Low Pass (300 Hz, 3 kHz, 15 kHz, None) De-emphasis (On, Off)
Measurement	NBFM Analyzer, NBFM Coverage, Quieting, SINAD
Auto Scan	Detection and frequency lock when RF In > +10 dBm, FM or CW signal
Tx Patterns	CW, FM w/ CTCSS/DCS/DTMF, FM w/ CTCSS/DCS/DTMF + Tone Modulation, FM + Tone Modulation
NBFM Analyzer	Active Graph, Maximize Active Trace, Graph Type, Audio Span, Audio Sweep Time, Occupied Bandwidth, Frequency Display (Carrier or Error)
Graph Type	Spectrum, Audio Spectrum, Audio Waveform/Scope, Summary Display
NBFM Coverage (requires Option 0031 GPS)	Display Type (Map or Time Graph) USB Memory File Format: .nbfm, .kml, both Log data on / off

**RF Measurements** (temperature range 15 °C to 35 °C)

Received Power dBm	± 1.25 dB, ± 0.5 dB typical
Frequency Error Hz	± 10 Hz + Frequency Reference
SINAD/Quieting	Audio In port conforms to TIA-603-D for input voltage and impedance
Additional Summary Measurements	Deviation Modulation Rate THD Occupied Bandwidth
Tone Decode	CTCSS/DCS (standard tones per TIA-603-D), DTMF

**Coverage Measurements**

RSSI, SINAD, THD

**NBFM Signal Generator**

**Setup Parameters**

Generator	On / Off
TX Output Level	0.1 dB resolution, 0 dBm to -130 dBm (spec to -120 dBm)
Frequency Accuracy	Same as Spectrum Analyzer



 **Interference Analyzer (Option 0025)**

Measurements	Spectrum Field Strength Occupied Bandwidth Channel Power Adjacent Channel Power Ratio (ACPR) AM/FM/SSB Demodulation (Wide/Narrow FM, Upper/Lower SSB), (audio out only) Carrier-to-Interference ratio (C/I) Spectrogram (Collect data up to one week) Signal Strength (Gives visual and aural indication of signal strength) Received Signal Strength Indicator (RSSI) (collect data up to one week) Gives visual and aural indication of signal strength Signal ID (up to 12 signals) Center Frequency Bandwidth Signal Type (FM, GSM, W-CDMA, CDMA, Wi-Fi) Closest Channel Number Number of Carriers Signal-to-Noise Ratio (SNR) > 10 dB Interference Mapping Triangulate location of interference with on display maps
Application Options	Bias-Tee (On/Off), Impedance (50 Ω, 75 Ω, Other)

**GPS Receiver Option (Option 0031)** (Antenna sold separately)

Setup	On/Off, Antenna Voltage 3.3/5.0 V, GPS Info
GPS Time/Location Indicator	Time, Latitude, Longitude and Altitude on display Time, Latitude, Longitude and Altitude with trace storage
GPS-Enhanced Frequency Accuracy	< 50 ppb with GPS On, 3 minutes after satellite is locked in selected mode (Applies to Spectrum Analyzer, Interference Analyzer, LMR Signal Analyzers)
Connector	SMA, Female

 **Coverage Mapping (Options 0431)**

**Measurements**

Indoor Mapping	Outdoor Mapping
RSSI	RSSI
ACPR	ACPR

**Setup Parameters**

Frequency	Center/Start/Stop, Span, Freq Step, Signal Standard, Channel #, Channel Increment
Amplitude	Reference Level (RL), Scale, Attenuation Auto/Level, RL Offset, Pre-Amp On/Off, Detection
Span	Span, Span Up/Down (1-2-5), Full Span, Zero Span, Last Span
BW	RBW, Auto RBW, VBW, Auto VBW, RBW/VBW, Span/VBW
Measurement Setup	ACPR, RSSI
Point Distance / Time Setup	Repeat Type Time Distance
Save Points Map	Save KML, JPEG, Tab Delimited
Recall Points Map	Recall Map, Recall KML Points only, Recall KML Points with Map, Recall Default Grid

 **Channel Scanner (Option 0027)**

Number of Channels	1 to 20 Channels
Measurements	Graph/Table, Max Hold (On/5 sec/Off), Freq/Channel, Current/Max, Single/Dual Color
Scanner	Scan Channels, Scan Frequencies, Scan Customer List, Scan Script Master™
Amplitude	Reference Level, Scale
Custom Scan	Signal Standard, Channel, # of Channels, Channel Step Size, Custom Scan
Frequency Accuracy	± 10 Hz + Frequency Reference
Measurement Range	-110 dBm to +26 dBm
Application Options	Bias-Tee (On/Off), Impedance (50 Ω, 75 Ω, Other)

 **CW Signal Generator**

**Setup Parameters**

Generator	On/Off
Tx Output Level	0.1 dB resolution, 0 dBm to -130 dBm (spec to -120 dBm)
Tx Pattern	CW, AM w/ 1 kHz, FM w/ 1 kHz

**RF Characteristics**

Power Level Accuracy	2.0 dB (CW Pattern, temperature range 15 °C to 35 °C, -120 dBm to 0 dBm) Typical
Frequency Range	500 kHz to 1.6 GHz
Frequency Accuracy	Same as Spectrum Analyzer

 **Internal Power Meter**

Frequency	Center/Start/Stop, Span, Frequency Step, Signal Standard, Channel #, Full Band
Amplitude	Maximum, Minimum, Offset, Relative On/Off, Units, Auto Scale
Average	Acquisition Fast/Med/Slow, # of Running Averages
Limits	Limit On/Off, Limit Upper/Lower
Frequency Range	10 MHz to 1.6 GHz (Standard), 10 MHz to 6 GHz (Option 6)
Span	1 kHz to 100 MHz
Display Range	-140 dBm to +30 dBm, ≤ 40 dB span
Measurement Range	-120 dBm to +26 dBm
Offset Range	0 dB to +100 dB
VSWR	2:1 typical
Maximum Power	Same as RF In Damage Level
Accuracy	Same as Spectrum Analyzer
Application Options	Impedance (50 Ω, 75 Ω, Other)

 **High Accuracy Power Meter (Option 0019)** (Requires external USB Power Sensor(s))

Amplitude	Maximum, Minimum, Offset, Relative On/Off, Units, Auto Scale
Average	# of Running Averages, Max Hold
Zero/Cal	Zero On/Off, Cal Factor (Center Frequency, Signal Standard)
Limits	Limit On/Off, Limit Upper/Lower

Power Sensor Model	<b>PSN50</b>	<b>MA24105A</b>	<b>MA24106A</b>	<b>MA24108A/18A/26A</b>
Description	High Accuracy RF Power Sensor	Inline High Power Sensor	High Accuracy RF Power Sensor	Microwave USB Power Sensor
Frequency Range	50 MHz to 6 GHz	350 MHz to 4 GHz	50 MHz to 6 GHz	10 MHz to 8 GHz (MA24108A) 10 MHz to 18 GHz (MA24118A) 10 MHz to 26 GHz (MA24126A)
Connector	Type N(m), 50 Ω	Type N(f), 50 Ω	Type N(m), 50 Ω	Type N(m), 50 Ω (MA24108A/18A) Type K(m), 50 Ω (MA24126A)
Dynamic Range	-30 dBm to +20 dBm (0.001 mW to 100 mW)	+3 dBm to +51.76 dBm (2 mW to 150 W)	-40 dBm to +23 dBm (0.1 μW to 200 mW)	-40 dBm to +20 dBm (0.1 μW to 100 mW)
VBW	100 Hz	100 Hz	100 Hz	50 kHz
Measurand	True-RMS	True-RMS	True-RMS	True-RMS, Slot Power, Burst Average Power
Measurement Uncertainty	± 0.16 dB <sup>1</sup>	± 0.17 dB <sup>2</sup>	± 0.16 dB <sup>1</sup>	± 0.18 dB <sup>3</sup>
Data sheet (for complete specifications)	11410-00414	11410-00621	11410-00424	11410-00504

Notes:

1. Total RSS measurement uncertainty (0 °C to 50 °C) for power measurements of a CW signal greater than -20 dBm with zero mismatch errors.
2. Expanded uncertainty with K = 2 for power measurements of a CW signal greater than +20 dBm with a matched load. Measurement results referenced to the input side of the sensor.
3. Expanded uncertainty with K = 2 for power measurements of a CW signal greater than -20 dBm with zero mismatch errors.



**P25/P25p2 Analyzer and P25/P25p2 Talk-Out Coverage (Options 0521, 0522)**

**Measurements**

<b>P25/P25p2 Analyzer (Option 0521)</b>	<b>P25/P25p2 Talk-Out Coverage (Option 0522, requires Option 0031 GPS)</b>
Received Power Frequency Error Modulation Fidelity NAC (hex) Symbol Rate Error BER (1011 Hz for P25, 1031 Hz for P25p2), O.153, Voice, and Control Channel) Symbol Deviation Color Code (P25p2 only)	BER RSSI Modulation Fidelity

**Graphs**

<b>P25/P25p2 Analyzer (Option 0521)</b>	<b>P25/P25p2 Talk-Out Coverage (Option 0522, requires Option 0031 GPS)</b>
Constellation (P25 only) Linear Constellation Spectrum [Spans (kHz) = 25, 50, 100, 500, 1000, 5000] Histogram Eye Diagram Summary Display TDMA Power Profile (P25p2 only)	Outdoor measured values are overlaid on a geo-tagged map, or displayed on a value vs time graph, and are exportable to both KML and CSV text (Requires option 0031 GPS and a suitable GPS antenna).  Indoor measured values are referenced by creating touchscreen points on a floorplan.

**Standards Compliance**

P25: Relevant sections of TIA-102.CAAA-C  
 P25 Phase 2: Relevant sections of TIA-102.CCAA

**Setup Parameters**

Frequency	Center Frequency
Amplitude	Reference level, Scale, Ext Attenuation, Auto Range, Adjust Range
Setup	P25 Modulation Types: C4FM, CQPSK P25 BER patterns: 1011 Hz, O.153 (V.52), Voice, Control Channel P25 Phase 2 Modulation Types: CQPSK Base & Mobile Station P25 Phase 2 BER patterns: 1031 Hz, Silence, Voice, Control Channel
Measurement	P25 Analyzer, P25 Coverage
P25/P25p2 Analyzer	Active Graph, Maximize Active Trace, Graph Type, Symbol Span
Graph Type	Constellation, Linear Constellation, Spectrogram, Histogram, Eye Diagram, Summary
Eye Diagram Symbol Span	2, 3, 4, 5
P25/P25p2 Coverage (Option 0522, requires Option 0031 GPS)	USB Memory File Format .p25, .kml, both Log data on / off

**RF Measurements (Option 0521) (temperature range 15 °C to 35 °C)**

Received Power dBm	± 1.25 dB, ± 0.5 dB typical
Frequency Error Hz	± 10 Hz + Frequency Reference
Additional Summary Measurements	Modulation Fidelity % BER/MER % Symbol Deviation (Hz) Network Access Code Hex Symbol Rate Error (MHz)

**Measurements (Option 0522)**

RSSI, BER, Modulation Fidelity



**Signal Generator**

**Setup Parameters**

Generator	On/Off
Tx Output Level	0.1 dB resolution, 0 dBm to -130 dBm (spec to -120 dBm)
P25 Tx Patterns	P25: 1011 Hz, 1011 Hz Cal, Intfr, Silence, Busy, Idle, High Dev, Low Dev, O.153 (v. 52), CW, AM and FM
P25p2 Tx Patterns	Base Station (Selectable timeslot): 1031 Hz, 1031 Hz Cal, Silence, CW, AM, FM Mobile Station (Selectable timeslot): 1031 Hz, 1031 Hz Cal, Silence, CW, AM, FM

**RF Characteristics**

Power Level Accuracy	2.0 dB (CW Pattern, temperature range 15 °C to 35 °C, -120 dBm to 0 dBm) Typical
Frequency Range	500 kHz to 1.6 GHz
P25/P25p2 Mod Fidelity	1.25 % max, 0.75 typical
Frequency Accuracy	Same as Spectrum Analyzer



**DMR2 Analyzer and DMR2 Talk-Out Coverage (Options 0591, 0592)**

**Measurements**

<b>DMR2 Analyzer (Option 0591)</b>	<b>DMR2 Talk-Out Coverage (Option 0592, requires Option 0031 GPS)</b>
Received Power Frequency Error Modulation Fidelity Color Code (decimal) RX & TX Timeslot Symbol Rate Error Symbol Deviation BER Mobile Station: 1031 Hz, 0.153, Voice, Silence, Idle and Control Channel Base Station: 1031 Hz, 1031 Hz 1% BER, 0.153, 0.153 1% BER, Silence, TSCC	BER RSSI Modulation Fidelity

**Graphs**

<b>DMR2 Analyzer (Option 0591)</b>	<b>DMR2 Talk-Out Coverage (Option 0592, requires Option 0031 GPS)</b>
Constellation Linear Constellation Spectrum [Spans (kHz) = 25, 50, 100, 500, 1000, 5000] Histogram Eye Diagram Summary Display	Outdoor measured values are overlaid on a geo-tagged map, or displayed on a value vs. time graph, and are exportable to both KML and CSV text (Requires option 0031 GPS and a suitable GPS antenna). Indoor measured values are referenced by creating touchscreen points on a floorplan.

**Setup Parameters**

Frequency	Center Frequency
Amplitude	Reference level, Scale, Ext Attenuation, Auto Range, Adjust Range
Setup	Modulation Type (Base Station, Mobile Station), BER pattern (1031 Hz, 0.153, Voice, Control Channel, Silence, Idle)
Measurement	DMR2 Analyzer, DMR2 Coverage
DMR2 Analyzer	Active Graph, Maximize Active Trace, Graph Type, Symbol Span
Graph Type	Constellation, Linear Constellation, Spectrogram, Histogram, Eye Diagram, Summary
Eye Diagram Symbol Span	2, 3, 4, 5
DMR2 Coverage (Option 0592, requires Option 0031 GPS)	USB Memory File Format .dmr2, .kml, both Log data on / off

**RF Measurements (Option 0591) (temperature range 15 °C to 35 °C)**

Received Power dBm	± 1.25 dB, ± 0.5 dB typical
Frequency Error Hz	± 10 Hz + Frequency Reference
Additional Summary Measurements	Modulation Fidelity % BER/MER % Symbol Deviation Hz Color Code Decimal Receive Timeslot Transmit Timeslot Symbol Rate Error (MHz)

**Measurements (Option 0592)**

RSSI, BER, Modulation Fidelity



**Signal Generator**

**Setup Parameters**

Generator	On/Off
Tx Output Level	0.1 dB resolution, 0 dBm to -130 dBm (spec to -120 dBm)
Tx Pattern	(Selectable timeslot) 1031 Hz, 0.153 (v. 52), Silence, 1031 Hz with 1% BER, 0.153 (v. 52) with 1% BER, TSCC (only available in Base Station Modulation Type), CW, AM and FM

**RF Characteristics**

Power Level Accuracy	2.0 dB (CW Pattern, temperature range 15 °C to 35 °C, -120 dBm to 0 dBm) Typical
Frequency Range	500 kHz to 1.6 GHz
Mod Fidelity	1.25 % max, 0.75 typical
Frequency Accuracy	Same as Spectrum Analyzer



**NXDN Analyzer and NXDN Talk-Out Coverage (Options 0531, 0532)**

**Measurements**

NXDN Analyzer (Option 0531)	NXDN Talk-Out Coverage (Option 0532, requires Option 0031 GPS)
Received Power Frequency Error Modulation Fidelity RAN (decimal) Symbol Rate Error BER (1031 Hz, 0.153, Voice, and Control Channel) Symbol Deviation	BER RSSI Modulation Fidelity

**Graphs**

NXDN Analyzer (Option 0531)	NXDN Talk-Out Coverage (Option 0532, requires Option 0031 GPS)
Constellation Linear Constellation Spectrum [Spans (kHz) = 25, 50, 100, 500, 1000, 5000] Histogram Eye Diagram Summary Display	Outdoor measured values are overlaid on a geo-tagged map and exportable to both KML and CSV text (Requires option 0031 GPS and a suitable GPS antenna). Indoor measured values are referenced by creating touchscreen points on a floorplan.

**Setup Parameters**

Frequency	Center Frequency
Amplitude	Reference level, Scale, Ext Attenuation, Auto Range, Adjust Range
Setup	Modulation Bandwidth (6.25 kHz and 12.5 kHz), BER pattern (1031 Hz, 0.153, Voice, Control Channel)
Measurement	NXDN Analyzer, NXDN Coverage
NXDN Analyzer	Active Graph, Maximize Active Trace, Graph Type, Symbol Span
Graph Type	Constellation, Linear Constellation, Spectrogram, Histogram, Eye Diagram, Summary
Eye Diagram Symbol Span	2, 3, 4, 5
NXDN Coverage (Option 0532, requires Option 0031 GPS)	USB Memory File Format .nxdn, .kml, both Log data on / off

**RF Measurements (Option 0531) (temperature range 15 °C to 35 °C)**

Received Power dBm	± 1.25 dB, ± 0.5 dB typical
Frequency Error Hz	± 10 Hz + Frequency Reference
Additional Summary Measurements	Modulation Fidelity % BER/MER % Symbol Deviation (Hz) Radio Access Number (RAN) Decimal Symbol Rate Error (MHz)

**Measurements (Option 0532)**

RSSI, BER, Modulation Fidelity



**Signal Generator**

**Setup Parameters**

Modulation Bandwidth	6.25 kHz, 12.5 kHz
Generator	On/Off
Tx Output Level	0.1 dB resolution, 0 dBm to -130 dBm (spec to -120 dBm)
Tx Patterns (9600 and 4800)	1031 Hz, 0.153 (v. 52), High Dev, Low Dev, UDCH Pattern 10, CAC, 1031 Hz DTS, FACCH3 DTS, Framed PN9, CW, AM, FM

**RF Characteristics**

Power Level Accuracy	2.0 dB (CW Pattern, temperature range 15 °C to 35 °C, -120 dBm to 0 dBm) Typical
Frequency Range	500 kHz to 1.6 GHz
Mod Fidelity	1.25 % max
Frequency Accuracy	Same as Spectrum Analyzer

 **PTC Analyzer and PTC Talk-Out Coverage (Options 0721, 0722)**

**Measurements**

<b>PTC Analyzer (Option 0721)</b>	<b>PTC Talk-Out Coverage (Option 0722, requires Option 0031 GPS)</b>
Received Power Frequency Error 4FSK: BER, Modulation Fidelity, Symbol Deviation, Symbol Rate Error Π/4 DQPSK: Error Vector Magnitude, BER, IQ Imbalance, Phase Error, Magnitude Error, Symbol Rate Error	BER RSSI Modulation Fidelity

**Graphs**

<b>PTC Analyzer (Option 0721)</b>	<b>PTC Talk-Out Coverage (Option 0722, requires Option 0031 GPS)</b>
Constellation Linear Constellation Spectrum [Spans (kHz) = 25, 50, 100, 500, 1000, 5000] Histogram Eye Diagram Summary Display	Outdoor measured values are overlaid on a geo-tagged map, or displayed on a value vs time graph, and are exportable to both KML and CSV text (Requires option 0031 GPS and a suitable GPS antenna).  Indoor measured values are referenced by creating touchscreen points on a floorplan.

**Setup Parameters**

Frequency	Center Frequency
Amplitude	Reference level, Scale, Ext Attenuation, Auto Range, Adjust Range
Setup	Modulation Type (4FSK, DQPSK) Symbol Rate (ksps) (6, 8, 12, 16) TX pattern Preamble + PN9, PN9 Only, CW, AM 1 kHz tone, FM 1 kHz tone
Measurement	PTC Analyzer, PTC Coverage
PTC Analyzer	Active Graph, Maximize Active Trace, Graph Type, Symbol Span
Graph Type	Constellation, Linear Constellation, Spectrogram, Histogram, Eye Diagram, Summary
Eye Diagram Symbol Span	2, 3, 4, 5
PTC Coverage (Option 0722, requires Option 0031 GPS)	USB Memory File Format .mtd, .kml, both Log data on / off

**RF Measurements (Option 0721)** (temperature range 15 °C to 35 °C)

Received Power dBm	± 1.25 dB, ± 0.5 dB typical
Frequency Error Hz	± 10 Hz + Frequency Reference
Additional Summary Measurements	Error Vector Magnitude % Phase Error degrees Magnitude Error % IQ Imbalance dB BER % Symbol Deviation (Hz) Radio Access Number (Hex) Symbol Rate Error (MHz)

**Measurements (Option 0722)**

RSSI, BER, Modulation Fidelity

 **Signal Generator**

**Setup Parameters**

Modulation Type	4FSK, Π/4 DQPSK
Symbol Rate (ksps)	6, 8, 12, 16
Generator	On/Off
Tx Output Level	0.1 dB resolution, 0 dBm to -130 dBm (spec to -120 dBm)
Tx Pattern	Preamble + PN9, PN9 Only, CW, AM 1 kHz tone, FM 1 kHz tone

**RF Characteristics**

Power Level Accuracy	2.0 dB (CW Pattern, temperature range 15 °C to 35 °C, -120 dBm to 0 dBm) Typical
Frequency Range	500 kHz to 1.6 GHz
Mod Fidelity	1.75 % max
Frequency Accuracy	Same as Spectrum Analyzer

 **AM/FM/PM Signal Analyzers (Option 0509)**

Measurements							
Display Type	RF Spectrum AM/FM/PM	Audio Spectrum (AM)	Audio Spectrum (FM/PM)	Audio Waveform (AM)	Audio Waveform (FM/PM)	Summary (AM)	Summary (FM/PM)
Graphic Display	Power (dBm) vs. Frequency	Depth (%) vs. Modulation Frequency	Deviation (kHz/rad) vs. Modulation Frequency	Depth (%) vs. Time	Deviation (kHz/rad) vs. Time	None	None
Numerical Displays	Carrier Power Carrier Frequency Occupied Bandwidth	AM Rate RMS Depth (Pk-Pk)/2 Depth SINAD* THD* Distortion/Total Vrms*	FM/PM Rate RMS Deviation (Pk-Pk)/2 Deviation SINAD* THD* Distortion/Total Vrms*	AM Rate RMS Depth (Pk-Pk)/2 Depth SINAD* THD* Distortion/Total Vrms*	FM/PM Rate RMS Depth (Pk-Pk)/2 Depth SINAD* THD* Distortion/Total Vrms*	RMS Depth (AM) Peak + Depth Peak - Depth (Pk-Pk)/2 Depth Carrier Power Carrier Frequency Occupied Bandwidth AM Rate SINAD* THD* Distortion/Total Vrms*	RMS Deviation (FM/PM) Peak + Depth Peak - Depth (Pk-Pk)/2 Depth Carrier Power Carrier Frequency Occupied Bandwidth AM Rate SINAD* THD* Distortion/Total Vrms*

\* Requires Sinewave modulation

**Setup Parameters**

Frequency	Center Freq, Span, Freq Step, Signal Standard, Channel, Channel Increment, Set Carrier Freq
Amplitude	Scale, Power Offset, Adjust Range
Setup	Demod Type (AM, FM, PM), IFBW, Auto IFBW
Measurements	RF Spectrum AM/FM/PM, Audio Spectrum (AM/FM/PM), Audio Waveform (AM/FM/PM), Summary (AM/FM/PM), Average
Marker	On/Off, Delta, Peak Search, Marker Freq to Center, Marker to Ref Lvl, Marker Table, All Markers Off

**Specifications**

AM	Modulation Rate: ± 1 Hz (< 100 Hz), ± 2% (> 100 Hz) Depth: ± 5% for modulation rates 10 Hz to 100 kHz
FM	Modulation Rate: ± 1 Hz (< 100 Hz); ± 2% (100 Hz to 100 kHz) Deviation Accuracy: ± 5% (100 Hz to 100 kHz)**
PM	Modulation Rate: ± 1 Hz (< 100 Hz); ± 2% (100 Hz to 100 kHz) Deviation Accuracy: ± 5% (deviation 0 to 93 Rad, rate 10 Hz to 5 kHz)**
IF Bandwidth	1 kHz to 300 kHz in 1-3 sequence
Frequency Span	RF Spectrum: 10 kHz to 10 MHz Audio Spectrum: 2 kHz, 5 kHz, 10 kHz, 20 kHz
RBW/VBW	30
Span/RBW	100
Sweep time	50 µs to 50 ms (Audio Waveform)

\*\* IFBW must be greater than 95 % occupied BW

 **LTE Signal Analyzers (Options 0541, 0542, 0546)**

**Measurements**

<b>RF (Option 0541)</b>	<b>Demodulation (Option 0542)</b>	<b>Over-the-Air (OTA) (Option 0546)</b>	<b>Pass/Fail (User Editable)</b>
Channel Spectrum Channel Power Occupied Bandwidth ACPR Spectral Emission Mask Category A or B (Opt 1) RF Summary	Power vs. Resource Block (RB) RB Power (PDSCH) Active RBs, Utilization %, Channel Power, Cell ID OSTP, Frame EVM by modulation Constellation QPSK, 16 QAM, 64 QAM Modulation Results Ref Signal Power (RS) Sync Signal Power (SS) EVM – rms, peak, max hold Frequency Error – Hz, ppm Carrier Frequency Cell ID Control Channel Power Bar Graph or Table View RS, P-SS, S-SS PBCH, PCFICH, PHICH, PDCCH Total Power (Table View) EVM Modulation Results Tx Time Alignment Modulation Summary Includes EVM by modulation Antenna Icons Detects active antennas (1/2)	Scanner Cell ID (Group, Sector) S-SS Power, RSRP, RSRQ, SINR Dominance Modulation Results – On/Off Tx Test Scanner RS Power of MIMO antennas Cell ID, Average Power Delta Power (Max-Min) Graph of Antenna Power Modulation Results – On/Off Mapping On-screen S-SS Power, RSRP, RSRQ, or SINR Scanner Modulation Results – Off	View Pass/Fail Limits All, RF, Modulation Available Measurements Channel Power Occupied Bandwidth ACLR Frequency Error Carrier Frequency Dominance EVM peak, rms RS Power RS EVM SS, P-SS, S-SS Power SS, P-SS, S-SS EVM PBCH Power PBCH EVM PCFICH Power PCFICH EVM PHICH Power, EVM PDCCH Power, EVM Cell, Group, Sector ID OSTP Tx Time Alignment

**Setup Parameters**

Frequency	E-UTRA bands 1 – 5, 7 – 14, 17 – 21, 23 – 25 (tunable 10 MHz to 4.0 GHz) Center, Signal Standard, Channel #, Closest Channel, Decrement/Increment Channel
Bandwidth	1.4, 3, 5, 10, 15, 20 MHz
Span	Auto, 1.4, 3, 5, 10, 15, 20, 30 MHz
Amplitude	Scale/Division, Power Offset, Auto Range, Adjust Range
Sweep	Single/Continuous, Trigger Sweep
EVM Mode	Auto, PBCH only
Save/Recall	Setup, Measurement, Screen Shot (save only), to Internal/External Memory
Measurement Summary Screens	Overall Measurements, RF Measurements, Modulation Measurements

**RF Measurements (Options 0541)**

RF Channel Power Accuracy	± 1.5 dB, ± 1.0 dB typical, (RF input –50 dBm to +10 dBm) (Option 0541) ± 1.5 dB, ± 1.0 dB typical, (RF input –30 dBm to +10 dBm) (Option 0551)
---------------------------	--

**Demodulation Measurements (Options 0542)**

Frequency Error	± 10 Hz + Frequency Reference, 99 % confidence level
Residual EVM (rms)	2.0% typical (E-UTRA Test Model 3.1, RF Input –50 dBm to +10 dBm) for BW ≤ 10 MHz 2.5% typical (E-UTRA Test Model 3.1, RF Input –50 dBm to +10 dBm) for BW > 10 MHz

**Over-the-Air (OTA) Measurements (Options 0546)**

Scanner	Six strongest signals if present Auto Save — Sync Signal Power and Modulation Results with GPS tagging
Auto Save	Scanner — three strongest signals if present RS Power — strongest signal
Mapping	Map On-screen S-SS Power, RSRP, RSRQ, or SINR of Cell ID with strongest signal Scanner — three strongest signals if present Save and Export Scanner data: *.kml, *.mtd (tab delimited)



**IEEE802.16 Fixed WiMAX Signal Analyzers (Options 0046, 0047)**

**Measurements**

<b>RF (Option 0046)</b>	<b>Demodulation (Option 0047)</b>	<b>Over-the-Air (OTA)</b>	<b>Pass/Fail (User Editable)</b>
Channel Spectrum Channel Power Occupied Bandwidth Power vs. Time Channel Power Preamble Power Data Burst Power Crest Factor ACPR	Constellation RCE (RMS/Peak) EVM (RMS/Peak) Frequency Error Carrier Frequency Base Station ID Spectral Flatness Adjacent Subcarrier Flatness EVM vs. Subcarrier/Symbol RCE EVM Frequency Error Carrier Frequency Base Station ID	There are no additional OTA Measurements. RF Measurements and Demodulation can be made OTA.	Channel Power Occupied Bandwidth Burst Power Preamble Power Crest Factor Frequency Error Carrier Frequency EVM RCE Base Station ID

**Setup Parameters**

Bandwidth	1.25, 1.50, 2.50, 3.50, 5.00, 5.50, 6.00, 7.00, 10.00 MHz
Cyclic Prefix Ratio (CP)	1/4, 1/8, 1/16, 1/32
Span	5, 10, 15, 20 MHz
Frame Length	2.5, 5.0, 10.0 ms
Frequency	Center, Signal Standard, Channel #, Closest Channel, Decrement/Increment Channel
Amplitude	Scale/Division, Power Offset, Auto Range, Adjust Range
Sweep	Single/Continuous, Trigger Sweep
Save/Recall	Setup, Measurement, Screen Shot (save only), to Internal/External Memory
Measurement Summary Screens	Overall Measurements, RF Measurements, Signal Quality Measurements

**RF Measurements (Option 0046)** (temperature range 15 °C to 35 °C)

RF Channel Power Accuracy ± 1.5 dB, ± 1.0 dB typical, (RF input -50 dBm to +20 dBm)

**Demodulation (Option 0047)** (temperature range 15 °C to 35 °C)

Frequency Error 0.07 ppm + Frequency Reference, 99 % confidence level  
 Residual EVM (rms) 3 % typical, 3.5 % maximum (RF Input -50 dBm to +20 dBm)



**IEEE 802.16 Mobile WiMAX Signal Analyzers (Options 0066, 0067, 0037)**

**Measurements**

<b>RF (Option 0066)</b>	<b>Demodulation (Option 0067)</b>	<b>Over-the-Air (OTA) (Option 0037)</b>	<b>Pass/Fail (User Editable)</b>
Channel Spectrum Channel Power Occupied Bandwidth Power vs. Time Channel Power Preamble Power Downlink Burst Power Uplink Burst Power ACPR	Constellation RCE (RMS/Peak) EVM (RMS/Peak) Frequency Error CINR Base Station ID Sector ID Spectral Flatness Adjacent Subcarrier Flatness EVM vs. Subcarrier/Symbol RCE (RMS/Peak) EVM (RMS/Peak) Frequency Error CINR Base Station ID Sector ID DL-MAP (Tree View)	Channel Power Monitor Preamble Scanner (Six) Preamble Relative Power Cell ID Sector ID PCINR Dominant Preamble Base Station ID	Channel Power Occupied Bandwidth Downlink Bust Power Uplink Burst Power Preamble Power Crest Factor Frequency Error Carrier Frequency EVM RCE Sector ID

**Setup Parameters**

Zone Type	PUSC
DL-MAP Auto Decoding	Convolutional Coding (CC), Convolutional Turbo Coding (CTC)
Bandwidths	3.50, 5.00, 7.00, 8.75, 10.00 MHz
Cyclic Prefix Ratio (CP)	1/8
Span	5, 10, 20, 30 MHz
Frame Lengths	5, 10 ms
Demodulation	Auto, Manual, FCH
Frequency	Center, Signal Standard, Channel #, Closest Channel, Decrement/Increment Channel
Amplitude	Scale/Division, Power Offset, Auto Range, Adjust Range
Sweep	Single/Continuous, Trigger Sweep
Save/Recall	Setup, Measurement, Screen Shot (save only), to Internal/External Memory
Measurement Summary Screens	Overall Measurements, RF Measurements, Signal Quality Measurements

**RF Measurements (Option 0066)** (Temperature range 15 °C to 35 °C)

RF Channel Power Accuracy ± 1.5 dB, ± 1.0 dB typical, (RF input -50 dBm to +20 dBm)

**Demodulation (Option 0067)** (Temperature range 15 °C to 35 °C)

Frequency Error 0.02 ppm + Frequency Reference, 99 % confidence level  
Residual EVM (rms) 2.5 % typical, 3.0 % maximum, (RF Input -50 dBm to +20 dBm)

**Over-the-Air (OTA) Measurements (Option 0037)**

Channel Power Monitor	Over time (one week), measurement time interval 1 to 60 sec
Preamble Scanner	Six Strongest Preambles
Auto Save	Yes
GPS Logging	Yes

**General Specifications**

All specifications and characteristics apply to rev 2 instruments under the following conditions, unless otherwise stated: 1) After 5 minutes of warm-up time, where the instrument is left in the ON state; 2) All specifications apply when using internal reference; 3) All specifications subject to change without notice; 4) Typical performance is the measured performance of an average unit and is not warranted; 5) Recommended calibration cycle is 12 months; 6) Performance Sweep Mode.

**Setup Parameters**

System	Status (Temperature, Battery Info, Serial Number, Firmware Version, Options Installed) Self Test, Application Self Test, GPS (see Option 0031)
System Options	Name, Date and Time, Brightness, Volume Language (English, French, German, Spanish, Chinese, Japanese, Korean, Italian, Russian, User defined) Reset (Factory Defaults, Master Reset, Update Firmware)
File	Save, Recall, Delete, Directory Management
Save/Recall	Setups, Measurements, Screen Shots Jpeg (save only)
Delete	Selected File, All Measurements, All Mode Files, All Content
Directory Management	Sort Method (Name/Type/Date), Ascend/Descend, Internal/USB, Copy, Format USB
Internal Trace/Setup Memory	2,000 traces, 2,000 setups
External Trace/Setup Memory	Limited by size of USB Flash drive
Mode Switching	Auto-Stores/Recalls most recently used Setup Parameters in the Mode

**Connectors**

VNA Port 1, VNA Port 2	Type N, female, 50 Ω
VNA Port Damage Level	23 dBm, ± 50 VDC
RF In Port	Type N, female, 50 Ω
RF In Port Damage Level	+33 dBm peak, ± 50 VDC, Maximum Continuous Input (≥ 10 dB attenuation)
Signal Generator Port	Type N, female, 50 Ω
Signal Generator Port Damage Level	+27 dBm, ± 50 VDC
GPS	SMA, female
External Power	5.5 mm barrel connector, 12.5 VDC to 15 VDC, < 4.0 Amps
USB Interface (2)	Type A (Connect USB Flash Drive and Power Sensor)
USB Interface	5-pin mini-B, Connect to PC for data transfer
Headset Jack	3.5 mm mini-phone plug
External Reference In	BNC, female, 50 Ω, Maximum Input +10 dBm, 1 MHz, 5 MHz, 10 MHz, 13 MHz
External Trigger/Clock Recovery	BNC, female, 50 Ω, Maximum Input ± 50 VDC

**Display**

Type	Resistive TFT Touchscreen
Size	8.4 inch daylight viewable color LCD
Resolution	800 x 600
Pixel Defects	No more than one defective pixel (99.9997% good pixels)

**Battery**

Type	Li-Ion, 6300 mAh rated capacity
Battery Operation	3.0 hours, typical

**Electromagnetic Compatibility**

European Union	CE Mark, EMC Directive 2004/108/EC Low Voltage Directive 2006/95/EC
Australia and New Zealand	C-tick N274
Interference	EN 61326-1
Emissions	EN 55011
Immunity	EN 61000-4-2/-4-3/-4-4/-4-5/-4-6/-4-11

**Safety**

Safety Class	EN 61010-1 Class 1
Product Safety	IEC 60950-1 when used with Anritsu supplied power supply

**Environmental**

Operating Temperature	-10 °C to 55 °C
Maximum Humidity	95% RH (non-condensing) at 40 °C
Shock	MIL-PRF-28800F Class 2
Explosive Atmosphere	MIL-PRF-28800F, Section 4.5.6.3 MIL-STD-810G, Method 511.5, Procedure 1
Storage	-40 °C to 71 °C
Altitude	4600 meters, operating and non-operating

**ESD**

RF Port Center Pin	Withstands up to ± 15 kV
--------------------	--------------------------

**Size and Weight**

Size	273 mm x 199 mm x 91 mm (10.7 in x 7.8 in x 3.6 in)
Weight	3.6 kg, (7.9 lbs)

**Master Software Tools** (for your PC)**Database Management**

Full Trace Retrieval	Retrieve spectrum analyzer traces from instrument into one PC directory
Trace Catalog	Index all traces into one catalog
Trace Rename Utility	Rename measurement traces
Group Edit	Titles, subtitles, plot scaling, markers and limit lines, simultaneously on similar files
DAT File Converter	Converts HHST files to MST file format and vice-versa

**Data Analysis**

Trace Math and Smoothing	Compare multiple traces
Data Converter	Convert from/to Return Loss, VSWR, Cable Loss, DTF and also into Smith Charts
Measurement Calculator	Translates into other units

**Report Generation**

Report Generator	Includes GPS, power level, and calibration status along with measurements
Edit Graph	Change scale, limit lines, and markers
Report Format	Create reports in HTML for PDF format
Export Measurements	Export measurements to *.s2p, *.jpg or *.csv format
Notes	Annotate measurements

**Mapping** (GPS Required)

Spectrum Analyzer Mode	MapInfo, MapPoint
------------------------	-------------------

**Folder Spectrogram** (Spectrum Monitoring for Interference Analysis and Spectrum Clearing)

Folder Spectrogram – 2D View	Creates a composite file of multiple traces Peak Power, Total Power, Peak Frequency, Histogram, Average Power (Max/Min) File Filter (Violations over limit lines or deviations from averages) Playback
Video Folder Spectrogram – 2D View	Create AVI file to export for management review/reports
Folder Spectrogram – 3D View	Views (Set Threshold, Markers) - 3D (Rotate X, Y, Z Axis, Level Scale, Signal ID) - 2D View (Frequency or Time Domain, Signal ID) - Top Down Playback (Frequency and/or Time Domain)

**List/Parameter Editors**

Traces	Add, delete, and modify limit lines and markers
Antennas, Cables, Signal Standards	Modify instrument's Antenna, Cable, and Signal Standard List
Product Updates	Auto-checks Anritsu website for latest revision firmware
Languages	Add up to two languages and modify non-English language menus
Display	Modify display settings

**Script Master™**

Channel Scanner Mode	Automate scan up to 1200 channels, repeat for sets of 20 channels, repeat all channels
GSM/GPRS/EDGE or W-CDMA/HSPA+ Mode	Automate Signal Analysis testing requirements with annotated how-to pictures

**Connectivity**

Connections	Connect to PC using USB
Download	Download measurements and live traces to PC for storage and analysis
Upload	Upload measurements from PC to instrument

 **Anritsu Tool Box and Line Sweep Tools** (for your PC)

Line Sweep Tools (LST) is a free PC based program that increases productivity for people who deal with numerous Cable and Antenna traces every day. LST is the next generation of Anritsu’s familiar Handheld Software Tools (HHST) and shares its uncomplicated user interface, giving a new face to the term “ease of use.”

Cable Editor <sup>1</sup>	Instrument Cable Lists may be retrieved from the instrument, modified as required, and uploaded back into instrument.
Distance to Fault <sup>2</sup> (DTF)	Easily convert Return Loss or VSWR traces to Distance to Fault traces with one button press.
Measurement Calculator	Provides quick conversion between commonly used measurement units such as VSWR, RL, and others.
Signal Standard Editor <sup>1</sup>	Signal Standard Lists may be retrieved from the instrument, modified as required, and uploaded back into instrument.
Naming Grid	A naming grid function makes changing file names, trace titles, and trace subtitles from field values to those required by contract simple and quick. Once the naming grid is populated with user defined file name segments, a few simple button presses will then fill out the file, title, and sub-title names. Quickly applied to multiple traces, the naming grid can save time, increase efficiency and accuracy.
Presets	Presets make applying markers and a limit line to similar traces quick and easy. They only need to be set once, and recorded. After this, applying them to a similar trace requires only one button push. This speeds up trace processing and makes providing consistent marker and limit line settings easy.
Report Generator	The report generator creates a professional PDF or HTML based report. Reports may include GPS <sup>3</sup> location, power level <sup>3</sup> , company logo <sup>4</sup> , instrument and calibration status along with a display of all open traces. It also may contain additional information such as addresses and phone numbers.
Capture	Plots to Screen, Database, *.dat, *.jpg
Connect	To PC using USB, Ethernet, Serial
Download/Upload <sup>1</sup>	Lists/measurements and live traces to PC for storage and analysis.
Supported File Types	Input: *.dat, *.vna, *.mna, *.pim, *.tm Output: *.dat, *.vna, *.pim, *.tm, *.csv, *.bmp, *.jpg, *.png

1. Instrument type/model must match original  
 2. Only \*.dat and \*.vna file types supported  
 3. Model dependent  
 4. Optionally set by user

## Ordering Information – Options

	<b>S412E</b>	<b>Description</b>
	500 kHz to 1.6 GHz	Vector Network Analyzer
	9 kHz to 1.6 GHz	Spectrum Analyzer
	10 MHz to 1.6 GHz	Power Meter
	500 kHz to 1.6 GHz	CW Signal Generator
	10 MHz to 1.66 GHz	NBFM Analyzer
	<b>Options</b>	
	S412E-0010	High Voltage Variable Bias Tee
	S412E-0501	Distance Domain
	S412E-0031	GPS Receiver (requires suitable GPS antenna)
	S412E-0019	High-Accuracy Power Meter (requires External Power Sensor)
	S412E-0025	Interference Analyzer (Option 0031 recommended)
	S412E-0027	Channel Scanner
	S412E-0006	6 GHz Coverage on Spectrum Analyzer
	S412E-0016	6 GHz Coverage on Vector Network Analyzer
	S412E-0015	Vector Voltmeter
	S412E-0431	Coverage Mapping (requires Option 0031)
	S412E-0509	AM/FM/PM Analyzer
	S412E-0521	P25/P25p2 Analyzer Measurements
	S412E-0522	P25/P25p2 Coverage Measurements (requires Options 0031 and 0521)
	S412E-0591	DMR2 Analyzer Measurements
	S412E-0592	DMR2 Coverage Measurements (requires Options 0031 and 0591)
	S412E-0531	NXDN Analyzer Measurements
	S412E-0532	NXDN Coverage Measurements (requires Options 0031 and 0531)
	S412E-0721	PTC Analyzer
	S412E-0722	PTC Coverage Measurements (requires Options 0031 and 0721)
	S412E-0541	LTE RF Measurements (requires Option 0031)
	S412E-0542	LTE Modulation Quality (requires Option 0031)
	S412E-0546	LTE Over-the-Air Measurements (requires Option 0031)
	S412E-0046	IEEE 802.16 Fixed WiMAX RF Measurements (requires Option 0031)
	S412E-0047	IEEE 802.16 Fixed WiMAX Demodulation (requires Option 0031)
	S412E-0066	IEEE 802.16 Mobile WiMAX RF Measurements (requires Option 0031)
	S412E-0067	IEEE 802.16 Mobile WiMAX Demodulation (requires Option 0031)
	S412E-0037	IEEE 802.16 Mobile WiMAX Over-the-Air Measurements (requires Option 0031)
	S412E-0098	Standard Calibration (ANSI Z540-1-1994)
	S412E-0099	Premium Calibration (ANSI Z540-1-1994) plus printed test data

**Standard Accessories** (Included with instrument)



Part Number	Description
10920-00060	Handheld Instruments Documentation Disc
10580-00318	LMR Master User Guide
2000-1654-R	Soft Carrying Case
2300-498	Master Software Tools (MST) CD Disc
2300-530	Anritsu Tool Box with Line Sweep Tools (LST) DVD Disc
633-75	Rechargeable 7500 mAh Li-Ion Battery
40-187-R	AC-DC Adapter
806-141-R	Automotive Cigarette Lighter 12V VDC Adapter
3-2000-1498	USB A-type to Mini USB B-type cable, 3.05 m (10 ft)
11410-00486	LMR Master S412E Technical Data Sheet One Year Warranty (Including battery, firmware, and software) Certificate of Conformance

**Power Sensors** (For complete ordering information see the respective data sheets of each sensor)



Model Number	Description
PSN50	High Accuracy RF Power Sensor, 50 MHz to 6 GHz, +20 dBm
MA24105A	Inline High/Peak Power Sensor, 350 MHz to 4 GHz, +3 dBm to +51.76 dBm
MA24106A	High Accuracy RF Power Sensor, 50 MHz to 6 GHz, +23 dBm
MA24108A	Microwave USB Power Sensor, 10 MHz to 8 GHz, +20 dBm
MA24118A	Microwave USB Power Sensor, 10 MHz to 18 GHz, +20 dBm
MA24126A	Microwave USB Power Sensor, 10 MHz to 26 GHz, +20 dBm

**Manuals** (Soft copy included on Handheld Instruments Documentation Disc and at www.anritsu.com)

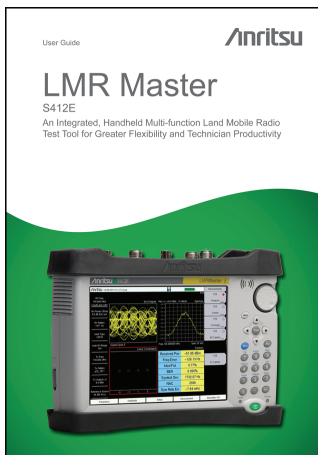

Part Number	Description
10920-00060	Handheld Instruments Documentation Disc
10580-00318	LMR Master User Guide (Hard copy included)
10580-00289	Vector Network Analyzer Measurement Guide
10580-00243	Land Mobile Radio Measurement Guide
10580-00241	Cable and Antenna Analyzer Measurement Guide
10580-00244	Spectrum Analyzer Measurement Guide - Interference Analyzer, Channel Scanner, Gated Sweep, CW Signal Generator, AM/FM/PM Analyzer, Interference Mapping, Coverage Mapping
10580-00240	Power Meter Measurement Guide - High Accuracy Power Meter
10580-00234	3GPP Signal Analyzer Measurement Guide - GSM/EDGE, W-CDMA/HSDPA, TD-SCDMA/HSDPA, LTE
10580-00236	WiMAX Signal Analyzer Measurement Guide - Fixed WiMAX, Mobile WiMAX
10580-00319	Programming Manual

**Troubleshooting Guides** (Soft copy at www.anritsu.com)

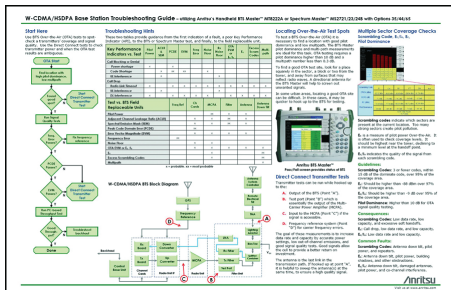

Part Number	Description
11410-00551	Spectrum Analyzers
11410-00472	Interference
11410-00566	LTE eNode Testing
11410-00473	Cable, Antenna, and Component Troubleshooting Guide
11410-00427	Understanding Cable & Antenna Analysis White Paper

## Optional Accessories

### Calibration Components, 50 Ω



Part Number	Description
OSLN50-1	Precision Open/Short/Load, N(m), 42 dB, 6.0 GHz, 50 Ω
OSLNF50-1	Precision Open/Short/Load, N(f), 42 dB, 6.0 GHz, 50 Ω
22N50	Open/Short, N(m), DC to 18 GHz, 50 Ω
22NF50	Open/Short, N(f), DC to 18 GHz, 50 Ω
SM/PL-1	Precision Load, N(m), 42 dB, 6.0 GHz, 50 Ω
SM/PLNF-1	Precision Load, N(f), 42 dB, 6.0 GHz, 50 Ω

### Directional Antennas



Part Number	Description
2000-1411-R	822 MHz to 900 MHz, N(f), 10 dBd, Yagi
2000-1412-R	885 MHz to 975 MHz, N(f), 10 dBd, Yagi
2000-1413-R	1710 MHz to 1880 MHz, N(f), 10 dBd, Yagi
2000-1414-R	1850 MHz to 1990 MHz, N(f), 9.3 dBd, Yagi
2000-1415-R	2400 MHz to 2500 MHz, N(f), 10 dBd, Yagi
2000-1416-R	1920 MHz to 2170 MHz, N(f), 10 dBd, Yagi
2000-1617-R	600 MHz to 21 GHz, N(f), 5-8 dBi to 12 GHz, 0-6 dBi to 21 GHz, log periodic

### Portable Antennas



Part Number	Description
2000-1200-R	806 MHz to 866 MHz, SMA(m), 50 Ω*
2000-1473-R	870 MHz to 960 MHz, SMA(m), 50 Ω*
2000-1035-R	896 MHz to 941 MHz, SMA(m), 50 Ω (1/2 wave)*
2000-1030-R	1710 MHz to 1880 MHz, SMA(m), 50 Ω (1/2 wave)*
2000-1474-R	1710 MHz to 1880 MHz with knuckle elbow (1/2 wave)*
2000-1031-R	1850 MHz to 1990 MHz, SMA(m), 50 Ω (1/2 wave)*
2000-1475-R	1920 MHz to 1980 MHz and 2110 MHz to 2170 MHz, SMA(m), 50 Ω*
2000-1032-R	2400 MHz to 2500 MHz, SMA(m), 50 Ω (1/2 wave)*
2000-1361-R	2400 MHz to 2500 MHz, 5000 MHz to 6000 MHz, SMA(m), 50 Ω*
2000-1636-R	Antenna Kit (Consists of: 2000-1030-R, 2000-1031-R, 2000-1032-R, 2000-1200-R, 2000-1035-R, 2000-1361-R, and carrying pouch)
2000-1487	Telescoping Whip Antenna, BNC **

\* Requires 1091-27-R SMA(f) to N(m) adapter

\*\* Requires 1091-172-R BNC(f) to N(m) adapter

### Filters



Part Number	Description
1030-114-R	806 MHz to 869 MHz, N(m) to SMA(f), 50 Ω
1030-109-R	824 MHz to 849 MHz, N(m) to SMA(f), 50 Ω
1030-110-R	880 MHz to 915 MHz, N(m) to SMA(f), 50 Ω
1030-105-R	890 MHz to 915 MHz, N(m) to N(f), 50 Ω
1030-111-R	1850 MHz to 1910 MHz, N(m) to SMA(f), 50 Ω
1030-106-R	1710 MHz to 1790 MHz, N(m) to N(f), 50 Ω
1030-107-R	1910 MHz to 1990 MHz, N(m) to N(f), 50 Ω
1030-112-R	2400 MHz to 2484 MHz, N(m) to SMA(f), 50 Ω
1030-149-R	High Pass, 150 MHz, N(m) to N(f), 50 Ω
1030-150-R	High Pass, 400 MHz, N(m) to N(f), 50 Ω
1030-151-R	High Pass, 700 MHz, N(m) to N(f), 50 Ω
1030-152-R	Low Pass, 200 MHz, N(m) to N(f), 50 Ω
1030-153-R	Low Pass, 550 MHz, N(m) to N(f), 50 Ω
1030-155-R	2500 MHz to 2700 MHz, N(m) to N(f), 50 Ω



**Optional Accessories** (Continued)

**Attenuators**

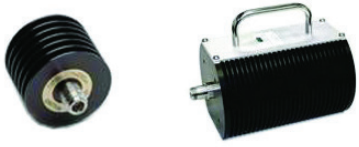

Part Number	Description
3-1010-122	20 dB, 5 W, DC to 12.4 GHz, N(m) to N(f)
42N50-20	20 dB, 5 W, DC to 18 GHz, N(m) to N(f)
42N50A-30	30 dB, 50 W, DC to 18 GHz, N(m) to N(f)
3-1010-123	30 dB, 50 W, DC to 8.5 GHz, N(m) to N(f)
1010-127-R	30 dB, 150 W, DC to 3 GHz, N(m) to N(f)
3-1010-124	40 dB, 100 W, DC to 8.5 GHz, N(m) to N(f), Uni-directional
1010-121	40 dB, 100 W, DC to 18 GHz, N(m) to N(f), Uni-directional
1010-128-R	40 dB, 150 W, DC to 3 GHz, N(m) to N(f)

**Phase-Stable Test Port Cables, Armored w/Reinforced Grip** (Recommended for cable & antenna line sweep applications)



Part Number	Description
15RNFN50-1.5-R	1.5 m, DC to 6 GHz, N(m) to N(f), 50 Ω
15RDFN50-1.5-R	1.5 m, DC to 6 GHz, N(m) to 7/16 DIN(f), 50 Ω
15RDN50-1.5-R	1.5 m, DC to 6 GHz, N(m) to 7/16 DIN(m), 50 Ω
15RNFN50-3.0-R	3.0 m, DC to 6 GHz, N(m) to N(f), 50 Ω
15RDFN50-3.0-R	3.0 m, DC to 6 GHz, N(m) to 7/16 DIN(f), 50 Ω
15RDN50-3.0-R	3.0 m, DC to 6 GHz, N(m) to 7/16 DIN(m), 50 Ω

**Phase-Stable Test Port Cables, Armored** (Recommended for use with tightly spaced connectors and other general purpose applications)



Part Number	Description
15NNF50-1.5C	1.5 m, DC to 6 GHz, N(m) to N(f), 50 Ω
15NN50-1.5C	1.5 m, DC to 6 GHz, N(m) to N(m), 50 Ω
15NDF50-1.5C	1.5 m, DC to 6 GHz, N(m) to 7/16 DIN(f), 50 Ω
15ND50-1.5C	1.5 m, DC to 6 GHz, N(m) to 7/16 DIN(m), 50 Ω
15NNF50-3.0C	3.0 m, DC to 6 GHz, N(m) to N(f), 50 Ω
15NN50-3.0C	3.0 m, DC to 6 GHz, N(m) to N(m), 50 Ω
15NNF50-5.0C	5.0 m, DC to 6 GHz, N(m) to N(f), 50 Ω
15NN50-5.0C	5.0 m, DC to 6 GHz, N(m) to N(m), 50 Ω

**Adapters**



Part Number	Description
1091-26-R	SMA(m) to N(m), DC to 18 GHz, 50 Ω
1091-27-R	SMA(f) to N(m), DC to 18 GHz, 50 Ω
1091-80-R	SMA(m) to N(f), DC to 18 GHz, 50 Ω
1091-81-R	SMA(f) to N(f), DC to 18 GHz, 50 Ω
1091-172-R	BNC(f) to N(m), DC to 1.3 GHz, 50 Ω
510-90-R	7/16 DIN(f) to N(m), DC to 7.5 GHz, 50 Ω
510-91-R	7/16 DIN(f) to N(f), DC to 7.5 GHz, 50 Ω
510-92-R	7/16 DIN(m) to N(m), DC to 7.5 GHz, 50 Ω
510-93-R	7/16 DIN(m) to N(f), DC to 7.5 GHz, 50 Ω
510-96-R	7/16 DIN(m) to 7/16 DIN (m), DC to 7.5 GHz, 50 Ω
510-97-R	7/16 DIN(f) to 7/16 DIN (f), DC to 7.5 GHz, 50 Ω
1091-379-R	Tuff-Grip TMA Bypass Adapter, 7/16 DIN(f) - 7/16 DIN(f), DC to 6 GHz, 50 Ω
510-102-R	N(m) to N(m), DC to 11 GHz, 50 Ω, 90 degrees right angle

**Precision Adapters**



Part Number	Description
34NN50A	Precision Adapter, N(m) to N(m), DC to 18 GHz, 50 Ω
34NFN50	Precision Adapter, N(f) to N(f), DC to 18 GHz, 50 Ω

**Optional Accessories** (Continued)

**Backpack and Transit Case**



Part Number	Description
67135	Anritsu Backpack (For Handheld Instrument and PC)
760-243-R	Large Transit Case with Wheels and Handle

**Miscellaneous Accessories**



Part Number	Description
2000-1528-R	GPS Antenna, SMA(m) with 15 foot cable
2000-1652-R	GPS Antenna, SMA(m) with 1 foot cable
633-75	Extra Extended Capacity Rechargeable 7500 mAh Battery Pack
2000-1374	External Charger for Li-Ion Batteries
2300-551	easyMap CD
2000-1653	Anti-glare Screen Cover (package of 2)
66864	Rack Mount Kit, Master Platform

**InterChangeable Adaptor Phase Stable Test Port Cables, Armored w/Reinforced Grip** (recommended for cable and antenna line sweep applications. It uses the same ruggedized grip as the Reinforced grip series cables. Now you can also change the adaptor interface on the grip to four different connector types)



Part Number	Description
15RCN50-1.5-R	1.5 m, DC to 6 GHz, N(m), N(f), 7/16 DIN(m), 7/16 DIN(f), 50 Ω
15RCN50-3.0-R	3.0 m, DC to 6 GHz, N(m), N(f), 7/16 DIN(m), 7/16 DIN(f), 50 Ω





To receive a quote to purchase a product or order accessories visit our online ordering site: [www.ShopAnritsu.com](http://www.ShopAnritsu.com)

## Training at Anritsu

Anritsu has designed courses to help you stay up to date with technologies important to your job. For available training courses visit: [www.anritsu.com/training](http://www.anritsu.com/training)

# Anritsu

### • United States

#### **Anritsu Company**

1155 East Collins Blvd., Suite 100,  
Richardson, TX 75081, U.S.A.  
Toll Free: 1-800-267-4878  
Phone: +1-972-644-1777  
Fax: +1-972-671-1877

### • Canada

#### **Anritsu Electronics Ltd.**

700 Silver Seven Road, Suite 120,  
Kanata, Ontario K2V 1C3, Canada  
Phone: +1-613-591-2003  
Fax: +1-613-591-1006

### • Brazil

#### **Anritsu Eletrônica Ltda.**

Praça Amadeu Amaral, 27 - 1 Andar  
01327-010 Paraisópolis, São Paulo, Brazil  
Phone: +55-11-3283-2511  
Fax: +55-11-3288-6940

### • Mexico

#### **Anritsu Company, S.A. de C.V.**

Av. Ejército Nacional No. 579 Piso 9, Col. Granada  
11520 México, D.F., México  
Phone: +52-55-1101-2370  
Fax: +52-55-5254-3147

### • United Kingdom

#### **Anritsu EMEA Ltd.**

200 Capability Green, Luton, Bedfordshire LU1 3LU,  
U.K.  
Phone: +44-1582-433280  
Fax: +44-1582-731303

### • France

#### **Anritsu S.A.**

12 Avenue du Québec,  
Bâtiment Iris 1-Silic 612,  
91140 VILLEBON SUR YVETTE, France  
Phone: +33-1-60-92-15-50  
Fax: +33-1-64-46-10-65

### • Germany

#### **Anritsu GmbH**

Nemetschek Haus, Konrad-Zuse-Platz 2  
81829 München, Germany  
Phone: +49-89-442308-0  
Fax: +49-89-442308-55

### • Italy

#### **Anritsu S.r.l.**

Via Elio Vittorini 129, 00144 Roma, Italy  
Phone: +39-06-509-9711  
Fax: +39-06-502-2425

### • Sweden

#### **Anritsu AB**

Borgafjordsgatan 13A, 164 40 KISTA, Sweden  
Phone: +46-8-534-707-00  
Fax: +46-8-534-707-30

### • Finland

#### **Anritsu Finland**

Teknobulevardi 3-5, 01530 Vantaa, Finland  
Phone: +358-20-741-8100  
Fax: +358-20-741-8111

### • Denmark

#### **Anritsu A/S (for Service Assurance)**

**Anritsu AB (for Test & Measurement)**  
Kay Fiskers Plads 9, DK-2300 Copenhagen S,  
Denmark  
Phone: +45-3691-5035  
Fax: +45-7211-2210

### • Russia

#### **Anritsu EMEA Ltd.**

**Representation Office in Russia**  
Tverskaya str. 16/2, bld. 1, 7th floor.  
Russia, 125009, Moscow  
Phone: +7-495-363-1694  
Fax: +7-495-935-8962

### • United Arab Emirates

#### **Anritsu EMEA Ltd.**

#### **Dubai Liaison Office**

P O Box 500413 - Dubai Internet City  
Al Thuraya Building, Tower 1, Suite 701, 7th Floor  
Dubai, United Arab Emirates  
Phone: +971-4-3670352  
Fax: +971-4-3688460

### • Singapore

#### **Anritsu Pte. Ltd.**

60 Alexandra Terrace, #02-08, The Comtech  
(Lobby A)  
Singapore 118502  
Phone: +65-6282-2400  
Fax: +65-6282-2533

### • India

#### **Anritsu India Pvt. Ltd.**

2nd & 3rd Floor, #837/1, Binnamangla 1st Stage,  
Indiranagar, 100ft Road, Bangalore - 560038, India  
Phone: +91-80-4058-1300  
Fax: +91-80-4058-1301

### • P.R. China (Shanghai)

#### **Anritsu (China) Co., Ltd.**

Room 1715, Tower A CITY CENTER of Shanghai,  
No.100 Zunyi Road, Chang Ning District,  
Shanghai 200051, P.R. China  
Phone: +86-21-6237-0898  
Fax: +86-21-6237-0899

### • Hong Kong

#### **Anritsu Company Ltd.**

Unit 1006-7, 10/F., Greenfield Tower,  
Concordia Plaza,  
No. 1 Science Museum Road, Tsim Sha Tsui East,  
Kowloon, Hong Kong  
Phone: +852-2301-4980  
Fax: +852-2301-3545

### • Japan

#### **Anritsu Corporation**

8-5, Tamura-cho, Atsugi-shi,  
Kanagawa, 243-0016 Japan  
Phone: +81-46-296-1221  
Fax: +81-46-296-1238

### • Korea

#### **Anritsu Corporation, Ltd.**

502, 5FL H-Square N B/D, 681  
Sampyeong-dong, Bundang-gu, Seongnam-si,  
Gyeonggi-do, 463-400 Korea  
Phone: +82-31-696-7750  
Fax: +82-31-696-7751

### • Australia

#### **Anritsu Pty Ltd.**

Unit 21/270 Ferntree Gully Road, Notting Hill  
Victoria, 3168, Australia  
Phone: +61-3-9558-8177  
Fax: +61-3-9558-8255

### • Taiwan

#### **Anritsu Company Inc.**

7F, No. 316, Sec. 1, Neihu Rd., Taipei 114, Taiwan  
Phone: +886-2-8751-1816  
Fax: +886-2-8751-1817

List Revision Date: 20121226

This Technical Data Sheet applies to Revision 2 of the S412E LMR Master. Refer to the sticker on the back of the instrument. Technical Data Sheets for previous instrument revisions (or S412E instruments not indicating a revision level on the sticker)



© Anritsu All trademarks are registered trademarks of their respective companies. Data subject to change without notice. For the most recent specifications visit: [www.anritsu.com](http://www.anritsu.com)  
Anritsu prints on recycled paper with vegetable soybean oil ink.

S412E LMR Master™ TDS  
Copyright May 2013 Anritsu Company, USA  
All Rights Reserved



11410-00486



H